

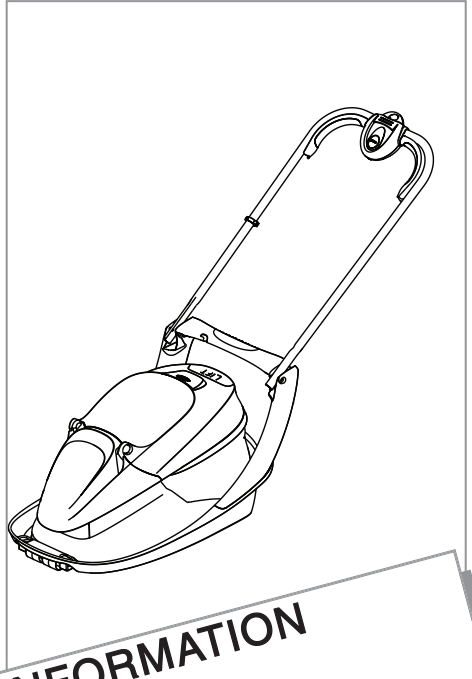

EASI GLIDE 300
 EASI GLIDE 300V
 EASI GLIDE 330
 EASI GLIDE 330VX



Original Instructions



IMPORTANT INFORMATION
 Read before use
 & retain for future reference

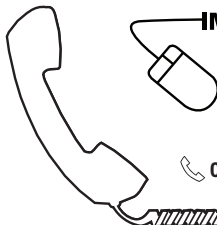

IMPORTANT Please register your product warranty on line.

To register your warranty and for all your parts requirements please visit

www.flymo.com

For all other enquiries

☎ 0344 844 4558 **UK** 1800 882 350 **ROI**

✉ customer.services@husqvarna.co.uk

Carton Contents

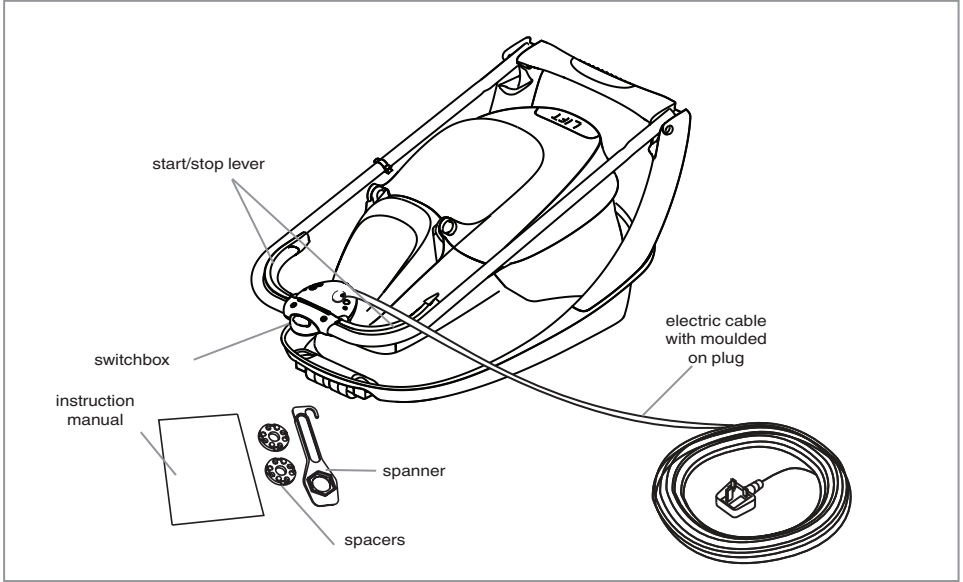

IMPORTANT!

Please check the contents of the carton are correct **BEFORE** assembling your new Flymo product.

IF ANY PARTS ARE MISSING CONTACT:-

Husqvarna UK Ltd. Customer Service Department direct

Telephone : 0344 844 4558 **UK** 1800 882 350 **ROI** Fax : 01325 302530

Safety



If not used properly this lawnmower can be dangerous! This lawnmower can cause serious injury to the operator and others. Read the instructions carefully. Be familiar with the controls and the proper use of the lawnmower. The operator is responsible for following the warning and safety instructions in this manual and on the lawnmower. Never use the lawnmower unless the grassbox or guards provided by the manufacturer are in the correct position.

Explanation of Symbols on your product.



Warning



Read the user instructions carefully to make sure you understand all the controls and what they do.



Beware of sharp blades - remove plug from mains before blades - remove plug from mains before maintenance or if cable is damaged. Blades continue to rotate after the machine is switched off.



Always keep the lawnmower on the ground when mowing. Tilting or lifting the lawnmower may cause stones to be thrown out



Keep bystanders away. Do not mow whilst people especially children or pets are in the mowing area



Keep the cable away from the blade.



General

1. This product is not intended for use by persons (including children) with reduced physical, sensory or mental capabilities, or lack of experience and knowledge, unless they have been given supervision or instruction concerning the use of the product by a person responsible for their safety. Children should be supervised to ensure that they do not play with the product. Local regulations may restrict the age of the operator.
2. Never allow children or people unfamiliar with the instructions to use the machine.
3. Stop using the machine while people, especially children, or pets are nearby.
4. Only use the lawnmower in the manner and for the functions described in these instructions.
5. Never operate the lawnmower when you are tired, ill or under the influence of alcohol, drugs or medicine.
6. The operator or user is responsible for accidents or hazards occurring to other people or their property.
7. Read the user instructions carefully to make sure you understand all the controls and what they do.

Electrical

1. We recommend the use of a Residual Current Device (R.C.D.) with a tripping current of not more than 30mA. Even with a R.C.D. installed 100% safety cannot be guaranteed and safe working practice must be followed at all times. Check your R.C.D. every time you use it.
2. Before use, examine the cable for signs of damage or ageing. If the cable is found to be defective, take the product to an Authorised Service Centre and have the cable replaced.
3. Do not use the lawnmower if the electric cables are damaged or worn.
4. Immediately disconnect from the mains electricity supply if the cable is cut, or the insulation is damaged. Do not touch the electric cable until the electrical supply has been disconnected. Do not repair a cut or damaged cable. Replace it with a new one.
5. Your extension cable must be uncoiled, coiled cables can overheat and reduce the efficiency of your mower.
6. Keep cable away from the blades, the blades can cause damage to the cables and lead to contact with live parts. Always work away from the power point mowing up and down, never in circles.
7. Do not pull cable around sharp objects.
8. Always switch off at the mains before disconnecting any plug, cable connector or extension cable.
9. Switch off, remove plug from mains and examine electric supply cable for damage or ageing before winding cable for storage. Do not repair a damaged cable, have it replaced with a new one.
10. Always wind cable carefully, avoiding kinking.
11. Never carry the product by the cable.
12. Never pull on the cable to disconnect any of the plugs.
13. Use only on AC mains supply voltage shown on the product rating label.
14. Our products are double insulated to EN60335. Under no circumstance should an earth be connected to any part of the product.

Preparation

1. While using your product always wear substantial footwear and long trousers. Do not operate when barefoot or wearing open sandals.
2. Make sure the lawn is clear of sticks, stones, bones, wire and debris; they could be thrown by the blade.
3. Before using the machine and after any impact, check for signs of wear or damage and repair as necessary.
4. Replace worn or damaged blades together with their fixings in sets to preserve balance.

Use

1. Use the lawnmower only in daylight or good artificial light.
2. Avoid operating your lawnmower in wet grass, where feasible.
3. On slopes, be extra careful of your footing and wear non-slip footwear.
4. Mow across the face of slopes, never up and down.
5. Exercise extreme caution when changing direction on slopes. Walk never run.
6. Do not mow excessively steep slopes.
7. Do not walk backwards when mowing, you could trip.
8. Never cut grass by pulling the mower towards you.
9. Switch off if the product has to be tilted for transportation, when crossing surfaces other than grass and when transporting the product to and from the area to be mowed.
10. Never operate the lawnmower with damaged guards or without guards in place.
11. Switch on the motor according to instructions and with feet well away from the blade(s).
12. Do not put hands or feet near or under rotating parts.
13. Do not tilt lawnmower when the motor is running.
14. Never pick up or carry a mower when it is operating or still connected to the mains supply.
15. Remove the plug from the mains :
 - before leaving the mower unattended for any period;
 - before clearing a blockage;
 - before checking, cleaning or working on the mower;
 - if you hit an object. Do not use your lawnmower until you are sure that the entire lawnmower is in a safe operating condition.;
 - if the lawnmower starts to vibrate abnormally. Check immediately. Excessive vibration can cause injury.

Maintenance and storage

1. Caution: Do not touch rotating blade.
2. Keep all nuts, bolts and screws tight to be sure the lawnmower is in safe working condition.
3. Check the grassbox/grassbag frequently for wear or deterioration.
4. Replace worn or damaged parts for safety.
5. Only use the replacement blade, blade bolt, spacer and impeller specified for this product.
6. Be careful during adjustment of the lawnmower to prevent entrapment of the fingers between moving blades and fixed parts of the machine.
7. If during the life of the product, the belt begins to slip. Return the product to an Authorised Service Dealer for maintenance.
8. Store in a cool dry place and out of reach of children. Do not store outdoors.
9. Allow the product to cool for at least 30 minutes before storing.

Cables

CABLES - IMPORTANT

If you want to use an extension cable when operating your product, only the following cable dimensions should be used:

- 1.0 mm² : max length 40 m
- 1.5 mm² : max length 60 m
- 2.5 mm² : max length 100 m

Minimum rating :

1.00mm² size cable, 10 amps 250 volts AC.

• YOUR PRODUCT IS SUPPLIED WITH CABLE WIRED DIRECTLY INTO THE PRODUCT.

1. If the supply cord is damaged, it must be replaced by your local Husqvarna UK Ltd. Approved Service Centre or similarly qualified persons in order to avoid a hazard.
2. Flymo Extension Cables are available from your local Husqvarna UK Ltd. Approved Service Centre.
3. Do not wire an extension cable directly to your product yourself. Please contact your local Husqvarna UK Ltd. Approved Service Centre for further information on the connectors and kits available.
4. Only use extension cables specifically designed for outdoor use and which conform to one of the following specifications: Ordinary rubber (60245 IEC 53), Ordinary PVC (60227 IEC 53) or Ordinary PCP (60245 IEC 57)

CONNECTORS - IMPORTANT

- Flymo connectors are suitable for use with 2 core cable only. Under no circumstances should these connectors be used for earthed products.
- All Flymo connectors and cables are of splashproof construction. They are not waterproof and must not be left outside permanently nor should they be sub-

merged or immersed in water. Do not let cable lay or trail through pools of water or splashed with water from hose pipes.

MAINS PLUG REPLACEMENT - IMPORTANT

- **If the plug supplied is cut off it should be destroyed. There is an electric shock hazard if a cut off plug is inserted into a 13 amp socket.**
1. **No earth required.** Flymo products are double insulated to EN60335 and under no circumstances should an earth be connected to any part of the product.
 2. **Ensure the mains voltage suits your product**
 3. **IMPORTANT!**
The wires in the mains lead are coloured in accordance with the following code:
BLUE - NEUTRAL
BROWN - LIVE
The wire which is coloured BLUE must be connected to the Terminal which is marked with the letter 'N' or coloured BLACK.
The wire which is coloured BROWN must be connected to the Terminal which is marked with the letter 'L' or coloured RED.
 4. It is important that the outer sheath is clamped correctly into the 3-pin plug.
 5. If in doubt consult your local Service Repairer or qualified electrician before the machine is used.
 6. **A 13 Amp fuse must be fitted to the Mains Plug.**
 7. The normal plug fuse and household fuse only protect the electrical equipment and are not a safeguard against electrocution.

Assembly

A



Preparing your lawnmower for use

- Your lawnmower is supplied with the upper handle folded over the machine for packing and transportation.

Handle in Operating Position

1. Lift handle as illustrated in figure A.
- Do not drop the handle.
- Make sure that the cable does not become trapped between the handles

Starting and Stopping

B

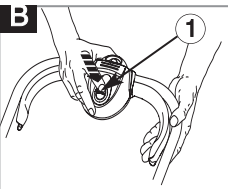

C

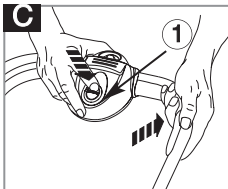

D

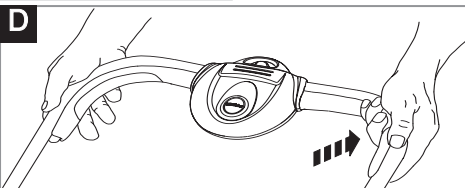

To Start your Lawnmower

1. Connect plug to mains and switch on.
- The switchbox is provided with a lock-off button (B1) to prevent accidental starting.**
2. Press and hold the lock-off button (B1) on the switchbox, then squeeze one of the Start/Stop levers towards the upper handle (C).
 3. Continue to squeeze the start/stop lever towards the upper handle and release the lock-off button (D)
- **NOTE: There are two start/stop levers fitted. Either one can be used for starting the lawnmower. IMPORTANT: Do not use the start/stop levers intermittently.**

To Stop your Lawnmower

1. Release the pressure on the Start/Stop lever.

How to Mow

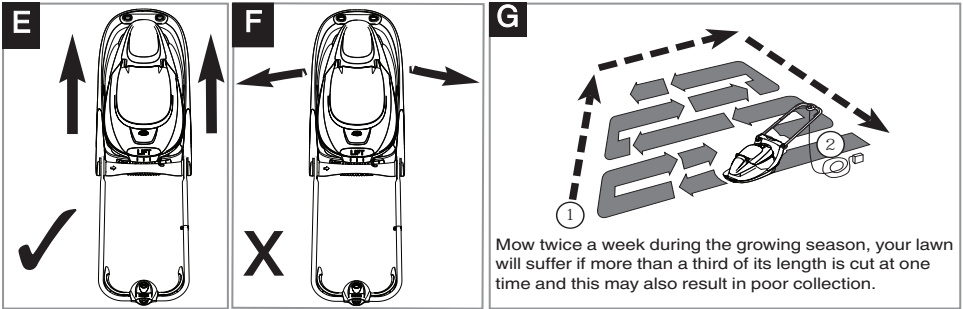

1. For the best results mow the outside edge of the lawn in a clockwise direction first. (G1)
2. Then start mowing the edge of the lawn nearest to the power point so the cable is laid out on the lawn you have already cut. (G2)
3. For best grass collection always mow in a straight line (E), do not swing the lawnmower from side to side (F)

Do Not Overload Your Mower

Mowing long thick grass may cause the motor speed to drop, you will hear a change in the motor sound. If the motor speed drops you may overload your lawnmower which may cause damage. When mowing in long thick grass a first cut with the cutting height set higher will help reduce the load. See Adjusting the Cutting Height.

Removing, Emptying and Refitting the Grassbox

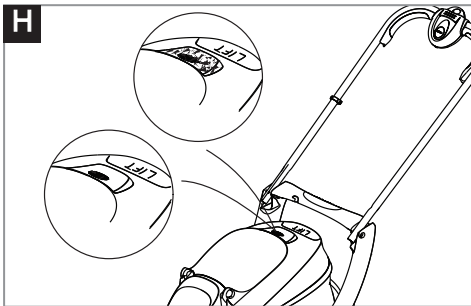

Grassbox Full Indicator (if fitted)

- Your lawnmower may be fitted with a vision window.
- **IMPORTANT**
When the window is full it is time to empty the grassbox.

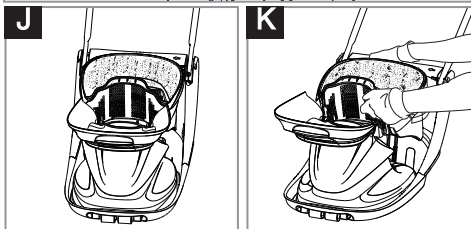

Emptying the Grassbox

- **Stop the lawnmower, as described in 'To Stop your Lawnmower' and wait until the blade has stopped rotating, BEFORE lifting the grassbox lid.**
1. Lift the grassbox lid and rest it against the motor cover (J).
 2. Remove the grassbox using the moulded handle recesses at the front and rear of the grassbox. (K).
 3. Empty grassbox.
 4. Replace grassbox and lid carefully.
 - **Failure to fit the grassbox and grassbox lid correctly will cause poor collection of grass clippings.**

Adjusting the Cutting Height

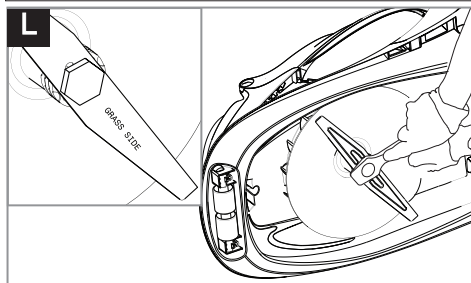

Always handle the blade with care - sharp edges could cause injury. **USE GLOVES.** Never use more than 3 Cutting Height Spacers. Spacers must only be fitted between the blade and the fan and NEVER between the blade and the bolt.

1. Remove the blade bolt, and blade as described in **Removing the Blade and Fan.**
2. **For a Lower Cut** - Add spacers to a maximum of 3.
3. **For a Higher Cut** - Take spacers away.
4. Refit the blade as described in **Fitting the Blade and Fan.**
5. For a healthy lawn, we recommend that you do not cut below 25mm (Use more than 2 spacers).
6. **Always ensure the text 'GRASS SIDE' will be facing the grass when the product is in the mowing position (L).**

Removing and fitting the Blade and Fan

Switch off and remove the plug from the mains.

Removing the Blade and Fan. USE GLOVES.

1. To remove the blade bolt, hold the fan firmly and with the spanner provided loosen the blade bolt by turning it anti-clockwise (L).
 2. Remove the blade bolt, blade, spacers and fan.(M)
 3. Inspect for damage and clean as necessary.
- Renew your metal blade after 50 hours mowing or 2 years whichever is the sooner - regardless of condition. If the blade is cracked or damaged replace it with a new one. Never use a blade bolt if the insulated head is damaged cracked or missing.

Fitting the Blade and Fan. USE GLOVES.

1. Ensure the fan (M4) is located correctly.
2. Place the spacers (M3) onto the fan ensuring the pegs have located into the holes.
3. Place the blade (M2) onto the spacers ensuring the text 'GRASS SIDE' (M5) will be facing the grass when the product is in the mowing position. Ensure the pegs have located into the holes on the blade and that the blade is positioned as illustrated in **Figure M**
4. Place the blade bolt (M1) through the centre hole of the blade.
5. Tighten down clockwise by hand.
6. Hold the fan firmly and tighten the blade bolt with the spanner provided.

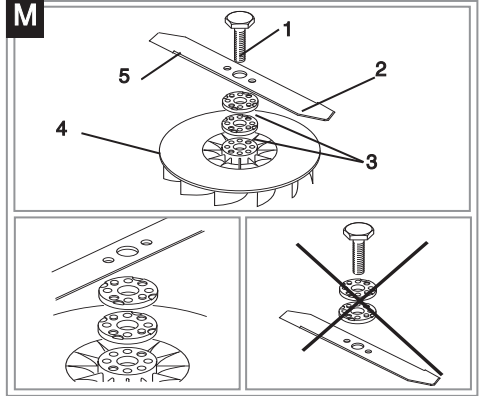

Caring for your Lawnmower

Cleaning

- **IMPORTANT:** It is very important that you keep your lawnmower clean. Grass clippings left in any of the air intakes or under the deck could become a potential fire hazard.

USE GLOVES

Switch off and remove the plug from the mains before cleaning.

It is recommended that you clean your lawnmower straight after mowing while the grass is still wet.

1. Remove grass from under the deck with the spanner/scrapper tool. (N)
 2. Using a soft brush - remove grass clippings from all air intakes, the grassbox and the grassbox vision window. (P & Q)
 3. Clean the impeller inlet with a soft brush. (R)
 4. If jammed lever the roller out of position and clean with a soft brush.(S).
 5. Wipe over the surface of your lawnmower with a dry cloth. (T)
- **IMPORTANT:** Never use water for cleaning your lawnmower. Do not clean with chemicals, including petrol, or solvents - some can destroy critical plastic parts

Storing the lawnmower

The handles can be folded to take up the minimum of space.

1. Hold onto the lower handle with your left hand (V).
 2. Hold the upper handle with your right hand and push in the direction of the arrow.
 3. Move the handle slowly forward to rest it on the lawnmower. Do not drop the handle.
- Ensure the switchbox cable is not trapped.
 - Store in a dry place where your lawnmower is protected from damage.

Transporting the lawnmower.

- The lawnmower may be transported on its roller (W).

At the End of the Mowing Season

1. Replace blade and blade bolt, if necessary.
2. Clean your lawnmower thoroughly.
3. Ask your local Service Centre to clean the air filter thoroughly and carry out any service or repairs required.

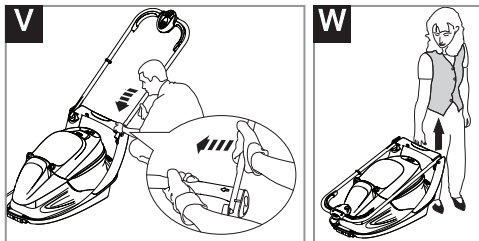
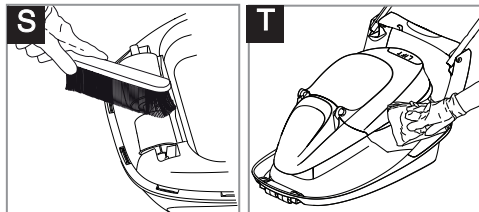
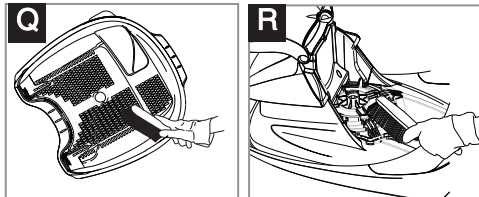
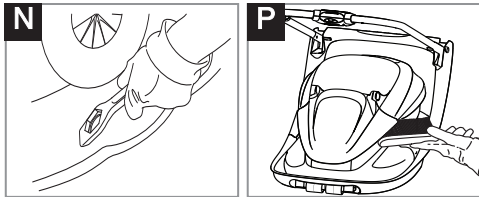

Fault Finding Hints

Fails to Operate

1. Is the correct Starting procedure being followed? See 'To Start your Lawnmower'
2. Is the Power Turned On?
3. Check the fuse in the plug, if blown replace.
4. Fuse continues to blow?

Immediately disconnect from the mains electricity supply and consult your local approved Service Centre.

Poor Flotation

1. Disconnect from the mains electricity supply.
2. Clean the underside of the deck and the fan blades.
3. Raise to a higher height of cut. See 'Adjusting the Cutting Height'.
4. If poor flotation persists?

Disconnect from the mains electricity supply and consult your local approved Service Centre.

Poor Collection

1. Is the grassbox lid firmly closed?
2. Is the grassbox fitted correctly?
3. See "How to Mow".
4. Check all air vents and openings are not obstructed.
5. Raise to a higher height of cut. See 'Adjusting the Cutting Height'.
6. If poor collection persists?

Disconnect from the mains electricity supply and consult your local approved Service Centre.

Excessive Vibration

1. Disconnect from the mains electricity supply.
2. Check that the blade is fitted correctly?
3. If the blade is damaged or worn, replace it with a new one.
4. If vibration persists?

Immediately disconnect from the mains electricity supply and consult your local approved Service Centre.

Service Recommendations

1. We strongly recommend that your product is serviced at least every twelve months, more often in a professional application.
2. Always use genuine Flymo Spare Parts.
3. Prepacked spares are available from most Husqvarna Outdoor Products stockists.
4. Your product is uniquely identified by a silver and black product rating label
5. If you have a problem with your machine contact your local Approved Service Centre ensuring you have full details of your product as described on the product rating label.
6. **Should it be necessary for work to be carried out by**

your Service Centre, it is important to take your complete machine including cable and any extension cables used.

A network of specialist dealers can be found in your local Yellow Pages.

To obtain service on your Flymo product simply telephone or visit your local Service Centre.

Should you require service under the terms of our guarantee the Service Centre will require proof of purchase.

All of the centres listed stock genuine Flymo Spare Parts.

NOTE: Our Service Repairers act on their own behalf and are not empowered to commit or legally bind Husqvarna UK Ltd. in any manner whatsoever.

Guarantee & Guarantee Policy

If any part is found to be defective due to faulty manufacture within the guarantee period, Husqvarna UK Ltd., through its Authorised Service Repairers will effect the repair or replacement to the customer free of charge providing:

- (a) The fault is reported directly to the Authorised Repairer.
 - (b) Proof of purchase is provided.
 - (c) The fault is not caused by misuse, neglect or faulty adjustment by the user.
 - (d) The failure has not occurred through fair wear and tear.
 - (e) The machine has not been serviced or repaired, taken apart or tampered with by any person not authorised by Husqvarna UK Ltd..
 - (f) The machine has not been used for hire.
 - (g) The machine is owned by the original purchaser.
 - (h) The machine has not been used commercially.
- * This guarantee is additional to, and in no way diminishes the customers statutory rights.

Failures due to the following are not covered, therefore it is important that you read the instructions contained in this Operator's Manual and understand how to operate and maintain your machine:

Failures not covered by guarantee

- * Replacing worn or damaged blades
- * Failures as a result of not reporting an initial fault.
- * Failures as a result of sudden impact.
- * Failures as a result of not using the product in accordance with the instructions and recommendations contained in this Operator's Manual.
- * Machines used for hire are not covered by this guarantee.
- * The following items listed are considered as wearing parts and their life is dependent on regular maintenance and are, therefore not normally subject to a valid warranty claim: Blades, Belt, Electric Mains cable.
- * **Caution!**
Husqvarna UK Ltd. does not accept liability under the warranty for defects caused in whole or part, directly or indirectly by the fitting of replacement parts or additional parts that are not either manufactured or approved by Husqvarna UK Ltd., or by the machine having been modified in any way

Replacement Parts

Blade :- EG300, EG300V

Reference no.: FLY004

Part no.: 512762990

Blade :- EG330, EG330VX

Reference no.: FLY027

Part no.: 511932390

Environmental Information

Husqvarna UK Ltd. are manufactured under an Environmental Management System (ISO 14001) using, where practical, components manufactured in the most environmentally responsible manner, according to company procedures, and with the potential for recycling at the end of the products' life.

- Packaging is recyclable and plastic components have been labelled (where practical) for categorised recycling.
- Awareness of the environment must be considered when disposing of 'end-of-life' product.
- If necessary, contact your local authority for disposal information.



The symbol on the product or on its packaging indicates that this product may not be treated as household waste. Instead it shall be handed over to the applicable collection point for the recycling of electrical and electronic equipment.

By ensuring this product is disposed of correctly, you will help prevent potential negative consequences for the environment and human health, which could otherwise be caused by inappropriate waste handling of this product. For more detailed information about recycling of this product, please contact your local council office, your household waste disposal service or the shop where you purchased the product.

EC Declaration of Conformity

Husqvarna AB, S-561 82, Huskvarna, Sweden

Declare under our sole responsibility that the product(s);

Designation.....**Lawnmower**
 Designation of Type(s).....**EG300, EG300V, EG330, EG330VX**
 Identification of Series.....**See Product Rating Label**
 Year of Construction.....**See Product Rating Label**

Complies with the essential requirements & provisions of the following EC Directives:
2006/42/EC, 2004/108/EC, 2000/14/EC, 2011/65/EU

based on the following EU harmonized standards applied:

EN60335-1, EN60335-2-77, EN62233, EN55014-1, EN61000-3-2, EN61000-3-3,

The maximum A weighted sound pressure level L_{pA} at the operator's position, measured according to EN60335-2-77, is given in the table.

The maximum hand / arm vibration weighted value a_{Hv} measured according to EN ISO 20643 on a sample of the above product(s) is given in the table.

2000/14/EC: The Measured Sound Power L_{WA} & Guaranteed Sound Power L_{WA} values are according to the tabulated figures.

Conformity Assessment Procedure..... Annex VI
 Notified Body..... Intertek, Cleeve Road
 Leatherhead, Surrey
 KT22 7SB, England

Husqvarna, 17/01/2013
 P. Lameli,
 Chief Technical Officer
 Keeper of technical documentation



Type	EG300	EG300V	EG330	EG330VX
Width of Cut (cm)	30	30	33	33
Speed of Rotation of Cutting Device (RPM)	4,300	4,300	4,300	4,300
Power (kW)	1.30	1.35	1.40	1.40
Measured Sound Power L_{WA} (dB(A))	89	89	89	89
Guaranteed Sound Power L_{WA} (dB(A))	91	91	91	91
Sound pressure L_{pA} (dB(A))	79	79	79	79
Uncertainty K_{pA} (dB(A))	2.5	2.5	2.5	2.5
Hand / arm vibration a_{Hv} (m/s ²)	< 2.5	<2.5	<2.5	<2.5
Uncertainty K_{aH} (m/s ²)	1.5	1.5	1.5	1.5
Weight (kg)	8.5	8.5	8.5	8.5

Our policy of continuous improvement means that the specification of products may be altered from time to time without prior notice.

Copyright © 2014 Flymo S.A. All rights reserved. Flymo® and other product and feature names are registered or un-registered trademarks of Flymo S.A.

Husqvarna AB,
 S-561 82
 Huskvarna,
 Sweden

5769982-04

