



# Assembly Instructions

Please keep for future reference

NEW ENGLAND STORAGE CABINET

CAT NO: QN912

CAT NO: UM241

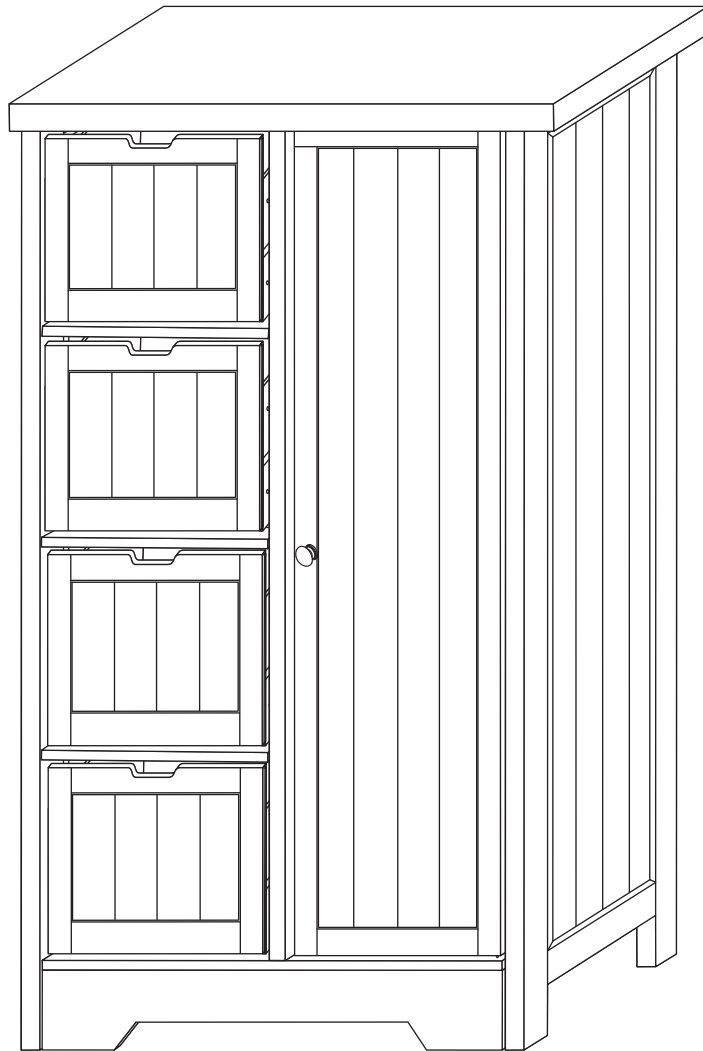

Dimensions	No. people	Assembly Time
------------	------------	---------------

Width: 56cm Depth: 30.5cm Height: 82cm		1 hour (approx.)
--	---	---------------------



**Important** - Please read these instructions fully before starting assembly

If you need help of have damaged or missing parts, calls the **JDW Customer Helpline: 0871 231 2000**



# Safety and Care Advice

## Important – Please read these instructions fully before starting assembly

- Check you have all the components and tools listed on page 2
- Remove all fittings from the plastic bags and separate them into their groups.
- Keep children and animals away from the work area, small parts could choke if swallowed.
- Make sure you have enough space to layout the parts before starting.

- During assembly do not stand or put weight on the product, this could cause damage.
- Assemble the item as close to its final position (in the same room) as possible.
- Assemble on a soft level surface to avoid damaging the unit or your floor.
- Parts of the assembly will be easier with 2 people.



- We do not recommend the use of power drill/drivers for inserting screws, as this could damage the using. Only use hand screwdrivers

## Care and maintenance

- Only clean using a damp cloth and mild detergent, do not use bleach or abrasive cleaners.
- From time to time check that there are no loose screws on this unit.
- This product should not be discarded with household waste. Take to your local authority waste disposal centre.

## Handy Hints

- Assemble all parts and bolts loosely during assembly, only once the product is complete should you fully tighten the bolts
- Regularly check and ensure that all bolts and fittings are tightend properly.

## WARNING

### In order to help prevent overturning – please follow these instructions

To help prevent product toppling over please follow the below steps:-

- Must use the anti tip strap or wall fixing method provided (Whichever applies)
- Do not allow children to climb or hang on the furniture
- Do not open more than one drawer at a time
- Do not place heavy items in the top drawers
- Do not place heavy items on top of the furniture, unless the furniture has been designed for this purpose

Please note that only the anti tip strap is provided.  
You will need to provide wall plugs and screws applicable for your wall type

# Components - Panels

Please check you have all the panels listed below

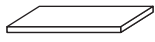

**1x1**  
56x30.5x1.5cm



**2x1**  
80.5x28.8x1.5cm



**3x1**  
80.5x28.8x1.5cm



**4x1**  
71.6x28.5x1.2cm



**5x2**  
24.5x4.5x1.2cm



**6x1**  
24.5x4.5x1.2cm



**7x1**  
71.3x24x1.5cm

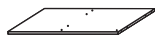

**8x1**  
50x28.5x1.2cm

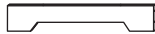

**9x1**  
50x7.5x1.2cm



**10x2**  
24.9x26.2x0.9cm

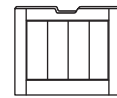

**11x4**  
24x16.5x1.5cm

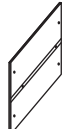

**12x8**  
27.6x11.8x0.9cm



**13x4**  
22x11.8x0.9cm



**14x4**  
26.5x22.7x0.3cm



**15x2**  
74x26x0.3cm

# Components - Fittings

Please check you have all the fittings listed below

Note: The quantities below are the correct amount to complete the assembly. In some cases more fittings may be supplied than are required.



**Ax26**  
5.8x30mm



**Bx16**  
6x35mm



**Cx16**  
12x10mm



**Dx32**  
3x30mm



**Ex1**



**Fx1**



**Gx8**



**Hx18**  
3x14mm



**Ix1**



**Jx1**  
4x16mm



**Kx8**



**Lx2**



**Mx23**  
2.5x12mm

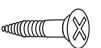

**Nx3**  
3x16mm



**Ox8**



**Px4**



**Qx1**



**Rx1**

## Tools required

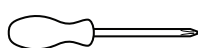

Phillips screwdriver  
(medium & large)

# Using Camlocks

## Step 1

Connect the male camlock as directed in the assembly instructions using a screwdriver.

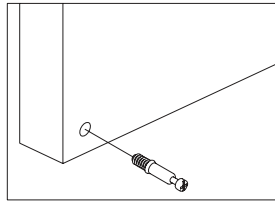

## Step 2

Insert the female camlock as shown in the instructions.

Note: ensure that the arrow on the top of the camlock points towards the entry hole for the male camlock.

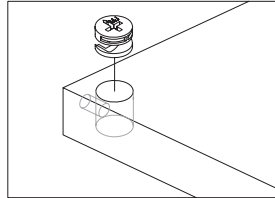

## Step 3

Push the male camlock into the entry hole.

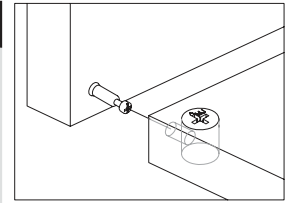

## Step 4

Turn the female camlock clockwise with a screwdriver.

You should feel a click when the camlock is locked in place.

The joint is now secure.

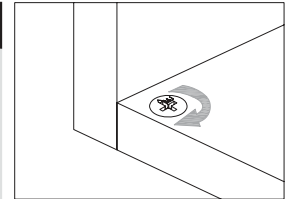

# Assembly Instructions

## Step 1

1. Into the underside of Top Panel **1** insert 6 x Male Camlocks **B** as shown. Connect magnetic catch **E** using 2 x Screw **N**

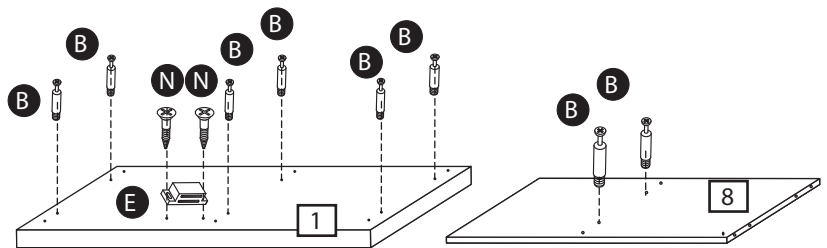

2. Into Base panel **8** insert 2 x Male Camlocks **B**

## Step 2

Connect 2 x Drawer sides **12** to 1 x Drawer Back **13** using 4 x Screw **D**

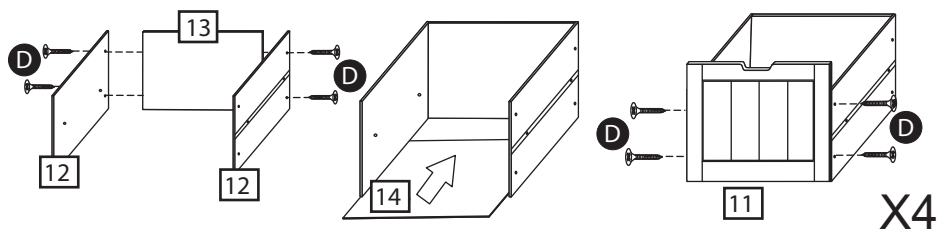

2. Slide Drawer base **14** into place.

3. Connect Drawer front **11** to side panels **12** using 4 x Screw **D**

Repeat to assemble remaining drawers

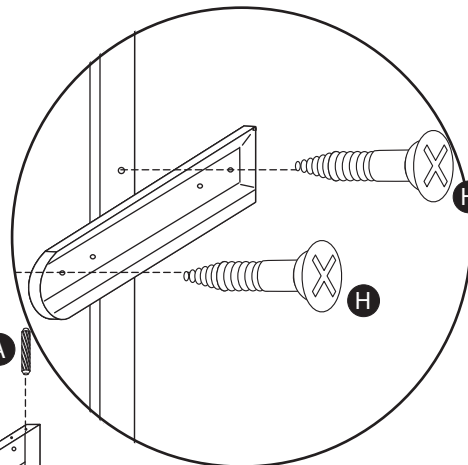

## Step 3

1. Insert 2 x Dowels **A** into the top of Left side panel **2**

2. Connect 4 x Drawer runners **G** to Left Side panel **2** using 8 x Screw **H**

3. Repeat for central panel **4**

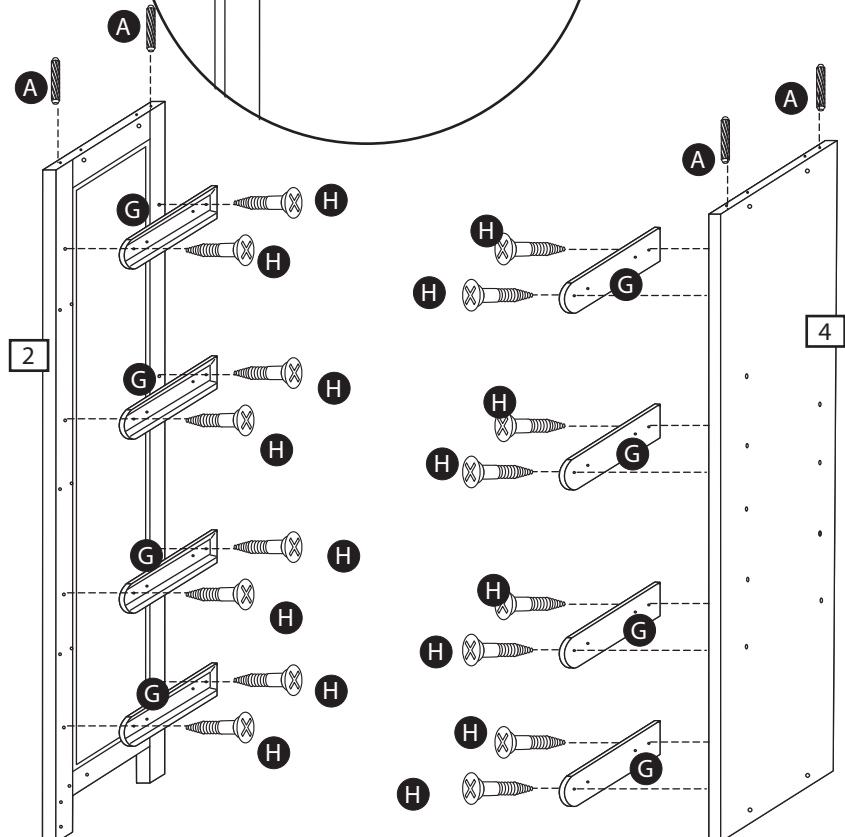

# Assembly Instructions

## Step 4

1. Insert 2 x Dowels **A** into the top and bottom of middle panel **4** as shown
2. Insert 4 x Dowels **A** into the edge of Base panel **8**
3. Into Front Plinth **9** insert 4 x Dowels **A**
4. Connect parts together as shown and insert 2 x Female Camlocks **C** into Middle panel **4**. Tighten with a Phillips Screwdriver

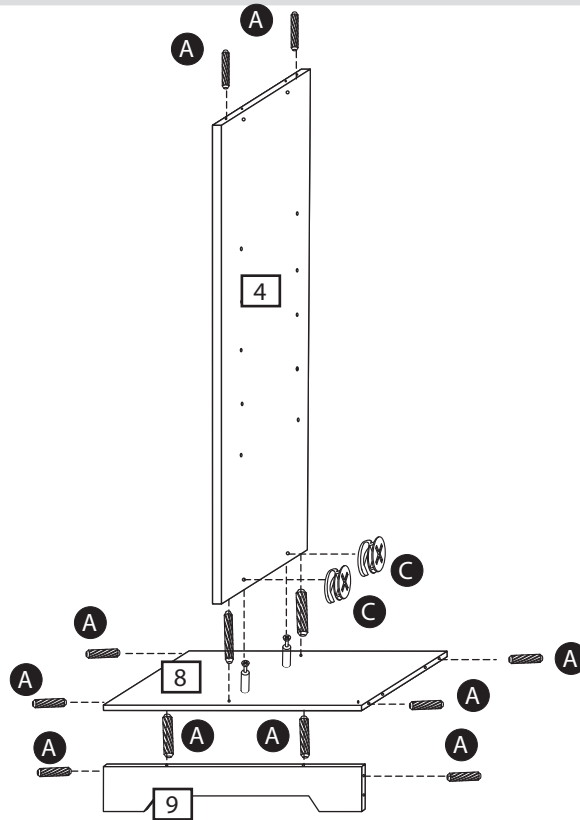

## Step 5

1. Into 2 x Support bar **5** insert 4 x Dowels **A** as shown.
2. Into 1 x Support Bar **6** insert 2 x Dowels **A**

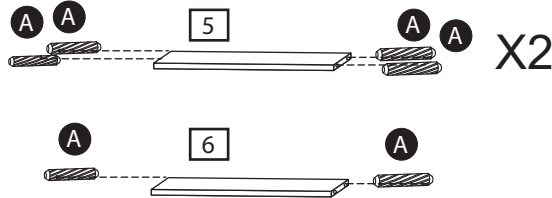

## Step 6

1. Into Left Side panel **2** insert 4 x male camlocks **B** in position shown
2. Into Middle Panel **4** insert 1 x Male camlocks **B**
3. Connect Parts together as shown. Insert 5 x female Camlocks **C** into holes shown. Tighten with a Phillips

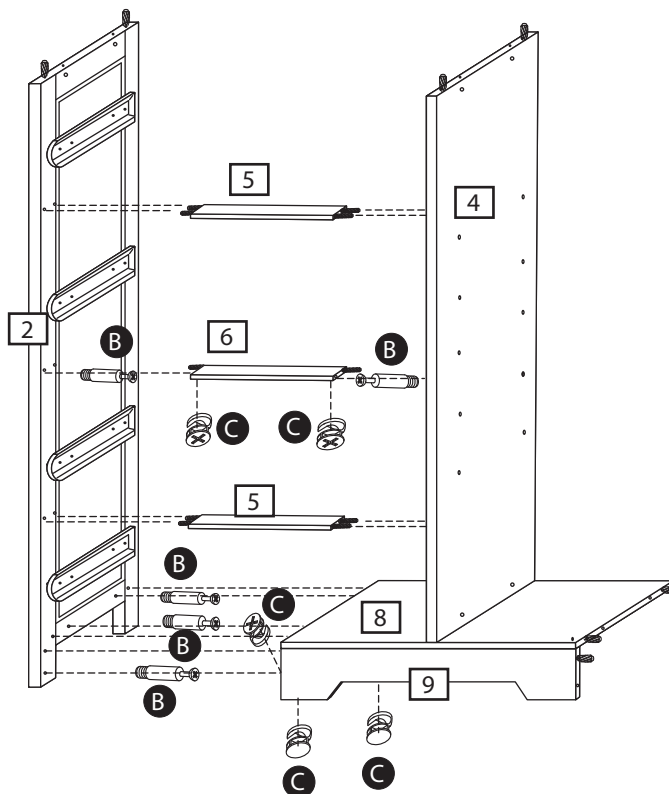

# Assembly Instructions

## Step 7

1. Into Right Side panel **3** insert 3 x male camlocks **B** in position shown

2. Connect Parts as shown and insert 3 x Female Camlocks **C**. Tighten with a Phillips Screwdriver

## Step 8

1. Into Door **7** insert 2 x Hinge Pins **L**

2. Locate Door into position shown, locating the bottom hinge into a hole in Base panel **8**

3. Locate Top Panel **1** onto the unit.

4. Insert 6 x Female Camlocks **C** into holes shown. Tighten with a Phillips Screwdriver

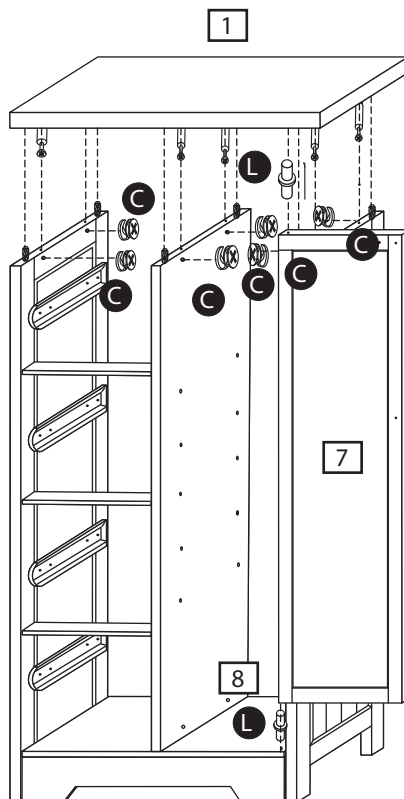
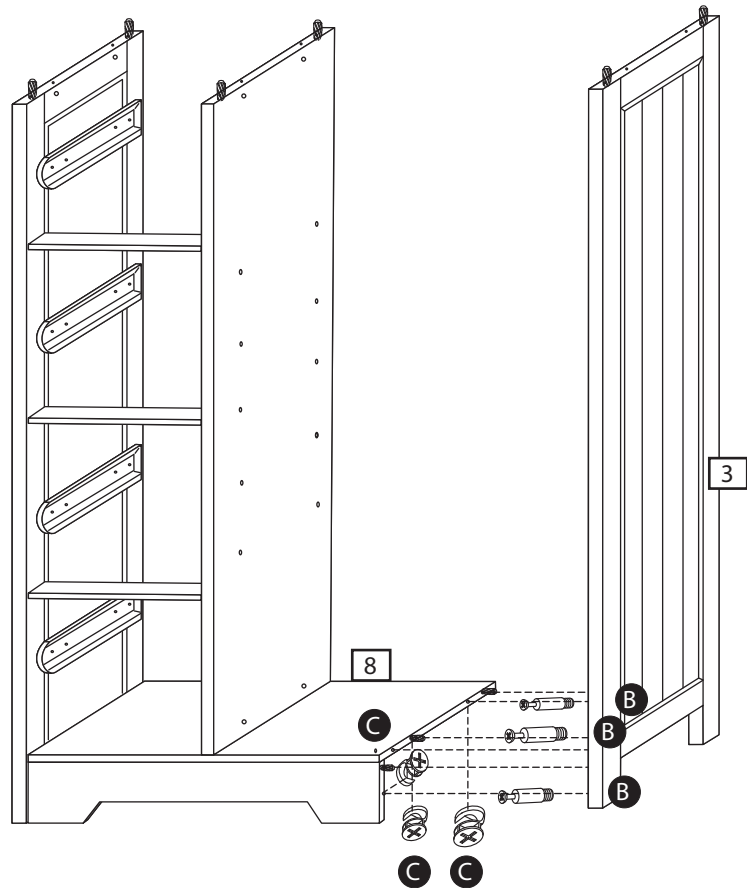

# Assembly Instructions

## Step 9

1. To door **7** connect Catch Plate **F** using 2 x Screws **H**
2. Connect your choice of handle, either handle **I** or **R** using screw **J**
3. Insert 8 x Shelf Supports **K** as shown

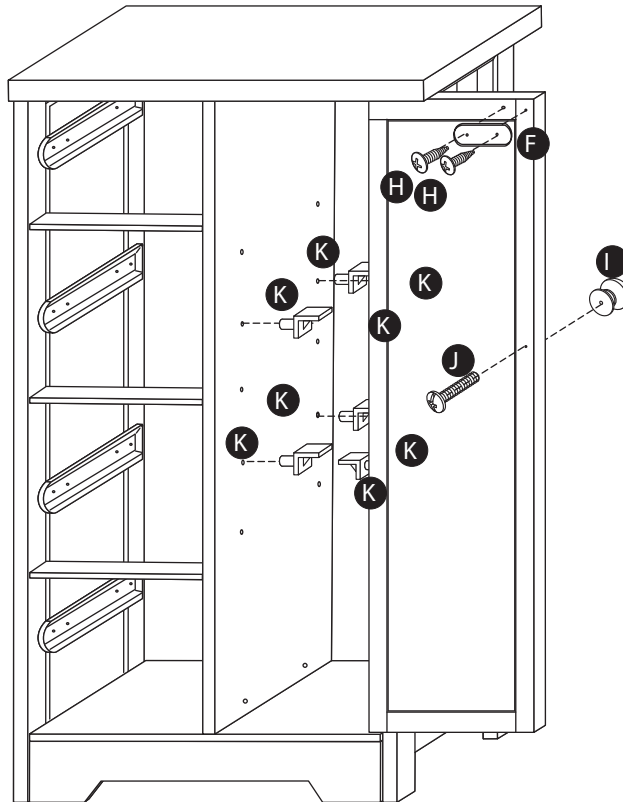

## Step 10

1. Connect 2 x Back Panel **15** to the reverse of the unit using 23 x Screw **M** as shown

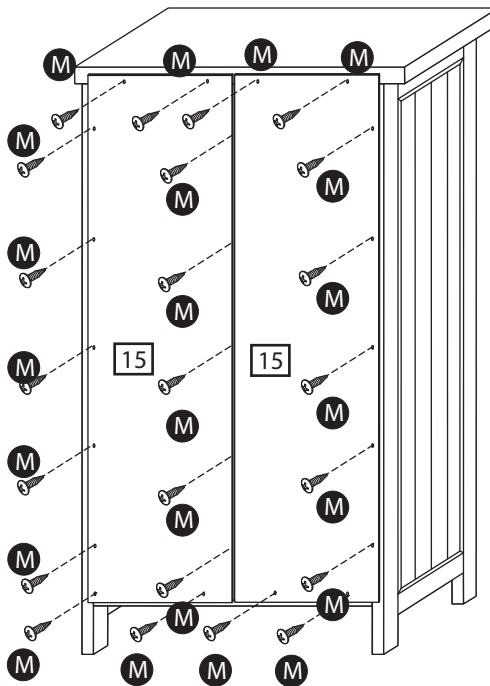

## Step 11

1. Add 4 x protective feet **P** to the bottom of the unit
2. Insert 2 x Shelves **10**
3. Insert 4 x Drawers
4. Insert 2 x Drawer stoppers **O** into each Drawer as shown

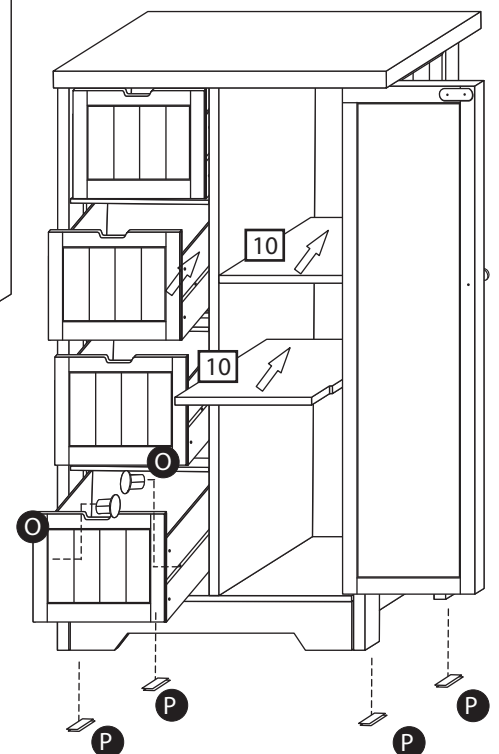



# Assembly Instructions

## Step 12

The unit is floor standing, but it is recommended that the unit is secured to the wall.

1. On the reverse of the unit, in position shown, fix 1 x Wall Straps **Q** using 1 x Screws **N**
2. Move the unit into desired position.
3. Mark the wall with a suitable scribe the position of the fixing hole.



**Warning:**

Before drilling, check wall for hidden pipes and cables.

4. Drill hole and insert a suitable Wall Plug, Please check the type of wall you are fixing to and for more information please see the guide to wall mounting & Fixings on the back page

5. Secure the strap to the wall using a suitable wall screw

*Note:* To hide the straps behind the unit, drill the holes lower than the top of the unit

**Assembly Complete**

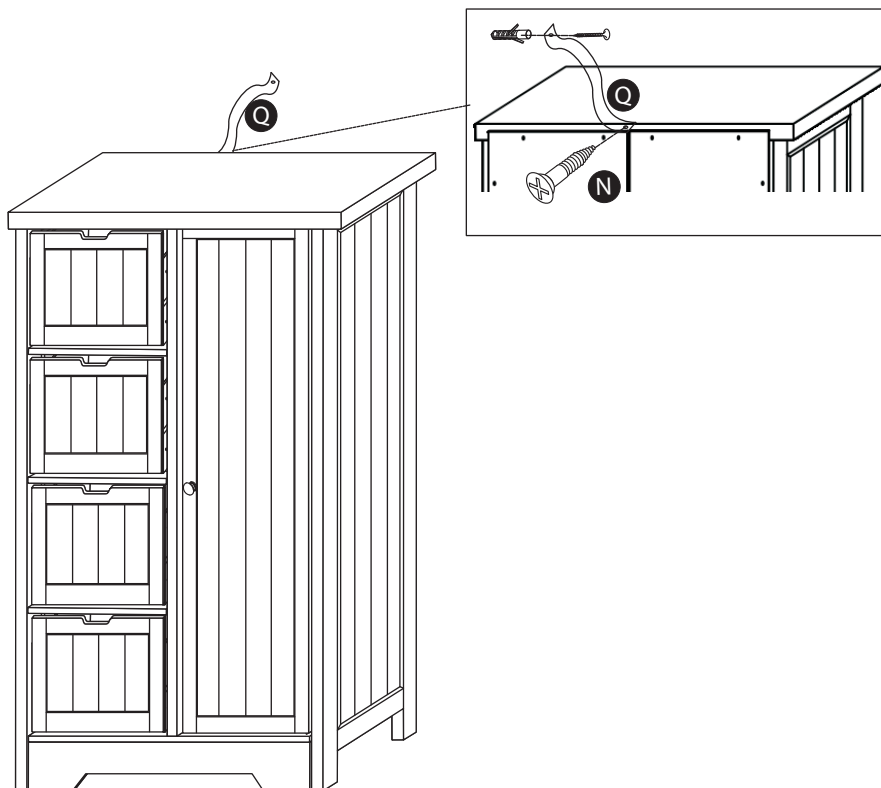

# A Guide to Wall Mounting & Fixings

## Important note:

If plastic wall plugs (rawl plugs) are supplied with your product, e.g.:



- these are only suitable for use in masonry walls.

If you are in any doubt about the correct wall plugs for your wall, seek professional advice.

Failure of the product due to using the incorrect fixings is the responsibility of the installer.



**Important:** when drilling into walls always check that there are no hidden wires or pipes etc.

Make sure that the screws and wall plugs being used are suitable for **supporting your unit**. **Consult a qualified tradesperson if you are unsure.**

Hints:

- 1: General rule:  always use a larger screw and wall plug if you are not sure.
- 2: Ensure you use the recommended drill bit to match the wall plug and hole size.
- 3: Ensure you drill the hole horizontally; do not force the drill or enlarge the hole.
- 4: Take extra care when drilling high walls, ceilings and ceramic tiles. Ensure wall plugs are inserted beyond the thickness of the ceramic tiles to avoid the tiles splitting or cracking.
- 5: Ensure wall plugs are well fitted and are a tight fit in the drilled hole.

## Types of walls

You can use one of the following types of wall plug if your walls are made of brick, breeze block, concrete, stone or wood.

No.1 "General Purpose" wall plug

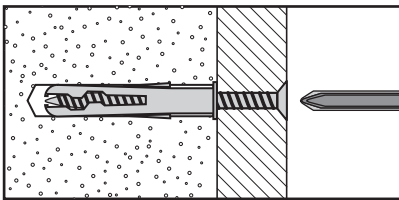

Generally aerated blocks should not be used to support heavy loads, use a specialist fitting in this case. For light loads, general purpose wall plugs can be used.

No.3 "Cavity Fixing" wall plug

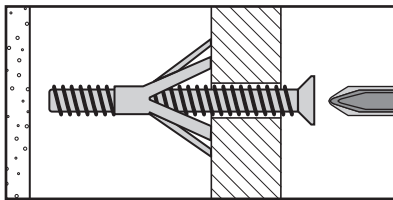

For use with plasterboard partitions or hollow wooden doors.

No.5 "Hammer Fixing" wall plug

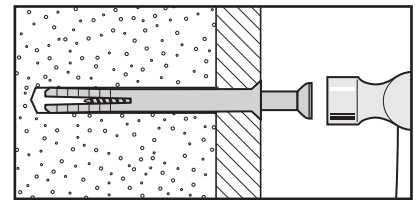

For use with walls stuck with plasterboard. The hammer fixing allows it to be fixed to the wall rather than the plasterboard. Always check the fixing is secure to the retaining wall.

No.2 "Plasterboard" wall plug

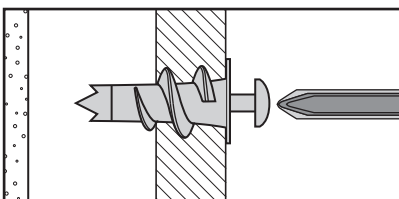

For use when attaching light loads onto plasterboard partitions.

No.4 "Cavity Fixing - Heavy Duty" wall plug

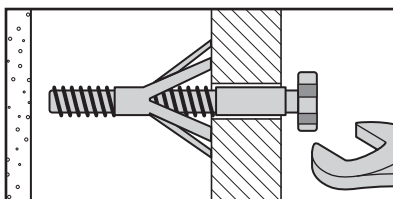

For use when fitting or supporting heavy loads such as shelving, wall cabinets and coat racks.

No.6 "Shield Anchor" wall plug - heavy loads

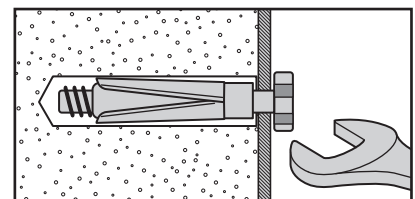

For use with heavier loads such as TV and HiFi speakers and satellite dishes etc.



## Care & Maintenance

**Safety:** always check the fitting and location to ensure your safety in and around the home.

**Fitting:** from time to time check the fitting to ensure the wall plugs or screws do not become loose.